

OST 455

ALUMINUM & uPVC

DOUBLE HEAD CUTTING MACHINE (Ø550MM SAW)

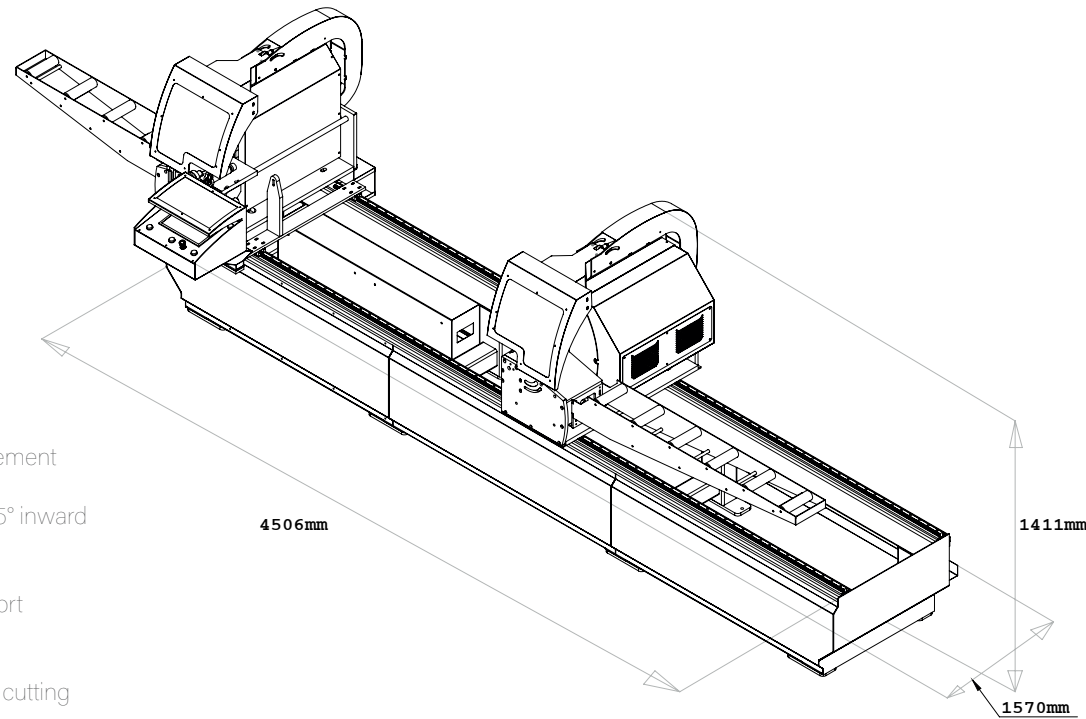

INFORMATION

- Hydro-pneumatic Hydrochek controlled saw movement
- Cutting accuracy +/- 0.1 mm
- Automatically adjustable to two angles 90° and 45° inward
- Automatic slicing at 90° angle
- 10" touch color panel display
- Providing remote connection and technical support
- 2x 550mm saw blade
- Servo motor motion system
- Saw exit distance is 180 mm and 80mmx2 profile cutting
- Hydrochek saw speed adjustment
- 8 Meters cutting feature
- Multi-language support
- Unlimited measurement memory capacity
- Spray saw cooling system
- 2 x vertical vices
- 4 x horizontal vices

OPTION

- Barcode printer
- Data transfer via USB memory stick

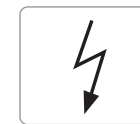
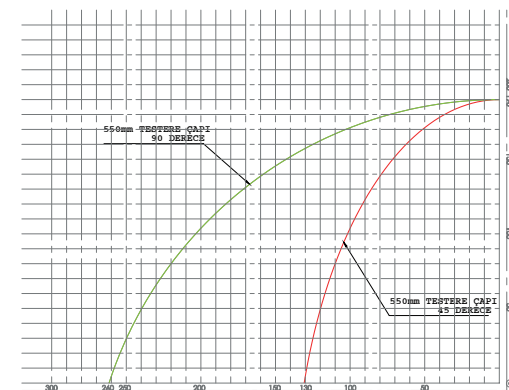

V : 400
kW : 7.3
A : 14

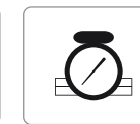

6-8 bar
30/lt/syc

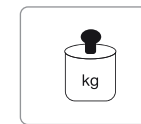

1470 kg.

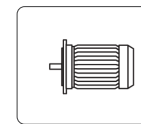

2x2.2 kW
2810 rpm

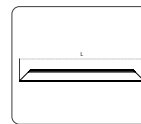

L max = 8000 mm
L min = 480 mm

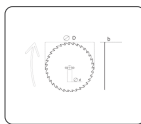

ØD 550 mm
Ød 30 mm
b 4,2 x 3,4 mm
z 120